



N.V. Radiofabriek en Ingenieursbureau v/h
VAN DER HEEM en BLOEMSMA

Apparaat: *KY 151*
Onderdeel: *ad. DC*

SCHEMA.

No. blad:

Dat: *29-3-35*

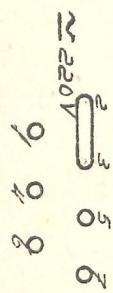
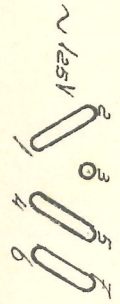
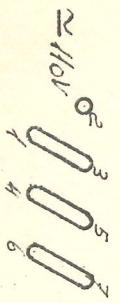

Auteursrecht volgens de wet voorbehouden...

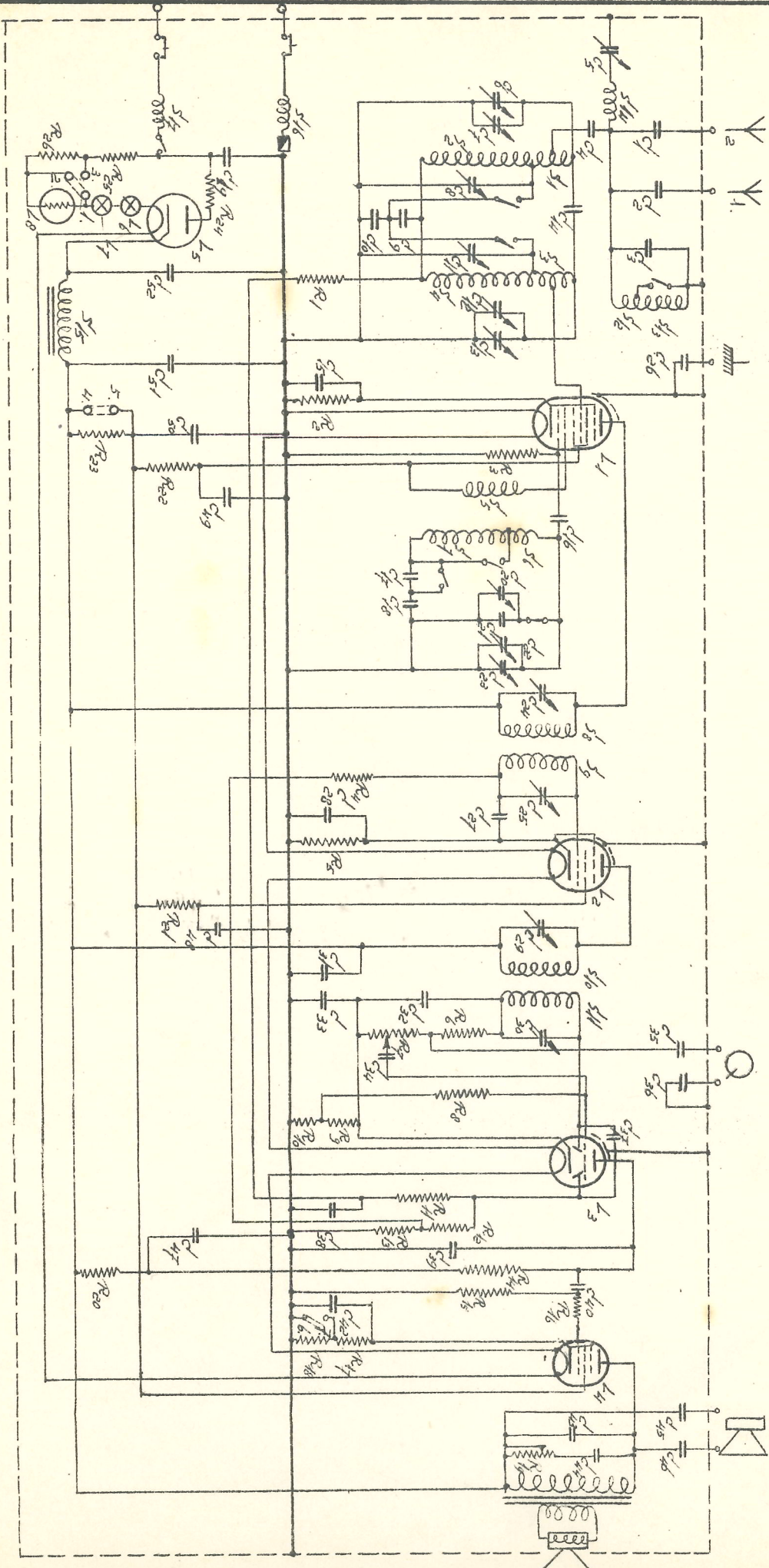

© van der Heem & Bloemsma documentatie centrum @
www.vanderheem.com erres.eu vdheem@planet.nl

araaf:
Huis



Condensatoren

o	Capaciteit	Codenummer
1	2000 μ F	28 198 920
2	320 "	28 190 130
3	100 "	130
4	40 "	090
5	140 "	28 210 540
6	450 "	
7	27 "	28 210 690
8	27 "	
9	50000 "	28 199 060
10	50000 "	
11	27 "	
12	27 "	
13	450 "	
14	0,5 "	
15	50000 "	
16	500 "	28 190 200
17	1210 "	790
18	1800 "	800
19	50000 "	
20	27 "	
21	32 "	28 190 080
22	27 "	
23	450 "	
24	140 "	
25	140 "	
26	10,25 μ F	
27	50000 μ F	
28	50000 "	
29	140 "	
30	140 "	
31	50000 "	
32	500 "	
33	25 μ F	28 180 610 25 V.
34	10000 μ F	
35	0,1 μ F	28 199 090
36	0,1 "	
37	20 μ F	
38	50000 "	
39	500 "	
40	50000 "	
42	25 μ F	25 V.
43	2000 μ F	
44	16000 "	28 199 010
45	0,1 μ F	
46	0,1 "	
47	0,25 "	28 199 130
48	50000 μ F	
49	50000 "	
50	4 μ F	
51	32 "	
52	32 "	

Veerststanden

R	Veerstand	Codenummer
1	1 M Ω	28 770 550
2	250 Ω	190
3	64000 "	430
4	1 M Ω	550
5	320 Ω	200
6	50000 "	420
7	0,5 M Ω	Frost
8	1 "	
9	1000 Ω	28 770 250
10	1000 "	
11	1 M Ω	
12	0,5 "	
13	0,5 "	
14	40000 Ω	28 770 410
15	0,2 M Ω	480
16	0,1 "	
17	2x 500 Ω	1 W. //
18	2x 320 "	1 W. //
19	50000 "	log. Phil.
20	20000 "	28 770 380
21	1000 "	
22	10000 "	
23	2x20000 "	1 W. //
24	2x 250 "	1 W. //
25	95 "	glasb. 0,2 A.
26	75 "	" 0,2 A.

Lampen:

L 1	CK 1
L 2	CF 3
L 3	CBC 1
L 4	CL 2
L 5	CY 1
L 6	C 3
L 7	} 6 V. 0,25 A. VIA
L 8	

Spoelen:

S		
1	= 132 w.	} GK 560 47
2	= 240 w.	
3	= 132 w.	} GK 560 48
4	= 240 w.	
5	= 50 w.	} GK 560 53
6	= 87 w.	
7	= 206 w.	
8	= 900 w.	} GK 560 50
9	= 900 w.	
10	= 900 w.	} GK 560 51
11	= 900 w.	
12	= 110 w.	} GK 560 54
13	= 600 w.	
14	= 975 w.	GK 560 55
15	= smoor spoel	28 550 440

~~Transformator GK 510 241~~

Luidspreker

Auteursrecht volgens de wet voorbehouden.

Auteursrecht volgens de wet voorbehouden.

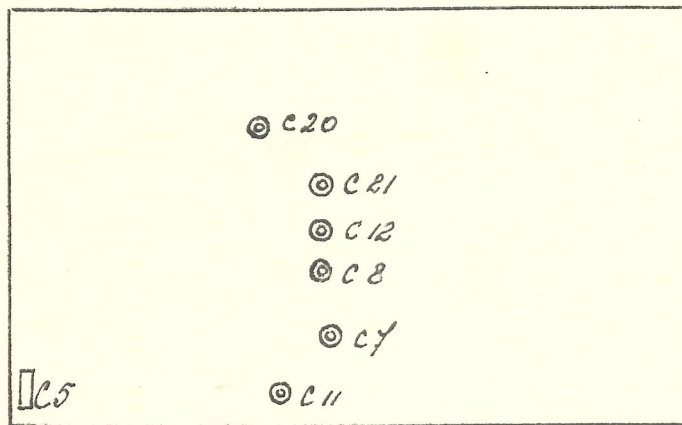
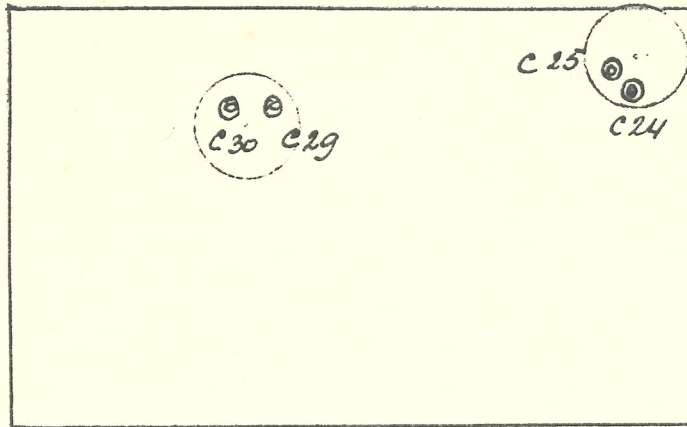

HOE-VEELHEID	OMSCHRIJVING MATERIAAL	AFMETINGEN MODEL-NP	NORM-AANDUIDING	CODE-NR	TEEK. AANW.	OPMERKINGEN	Post NR
MATERIAAL:			UITVOERING:				
OMSCHRIJVING: FRID. OORSCHRIJFT WY151			Laatste wijz. dat.:	\checkmark = VOORBEWERKT \overline{VV} = NABEWERKT \overline{VVV} = GLADBEWERKT	25 = \pm 0,5 25,0 = \pm 0,2 25,0 = \pm 0,05	A 4	
 N.V. Radiofabriek en Ingenieursbureau v/h VAN DER HEEM en BLOEMSMA		Schaal:	Dat.:	CODE NR			
		Get.:	Gez.:				